

THE INFORMATION CONTAINED HEREIN IS PROPRIETARY AND CONFIDENTIAL TO EIC SOLUTIONS, INC. ANY USE, TRANSFER, OR DUPLICATION OF THIS INFORMATION IS STRICTLY FORBIDDEN WITHOUT THE EXPRESS WRITTEN CONSENT OF EIC SOLUTIONS, INC.

REV	DESCRIPTION	CHECKED	DATE	NOTES
-----	-------------	---------	------	-------

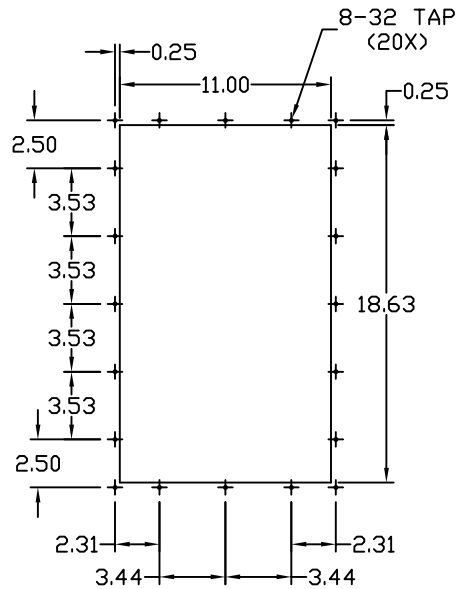

ENCLOSURE CUTOUT

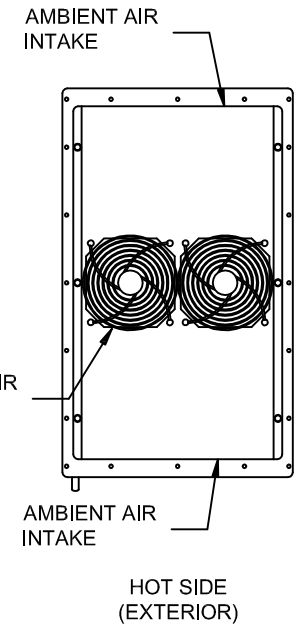
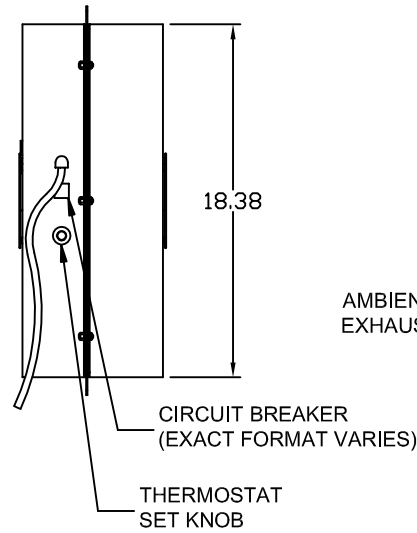
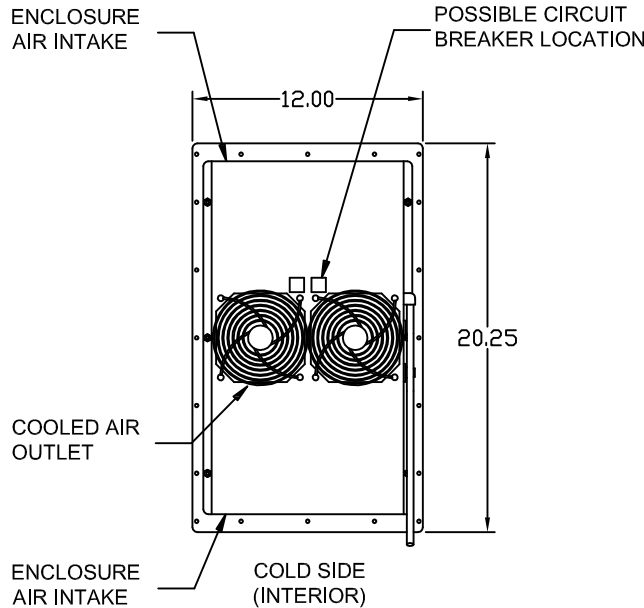
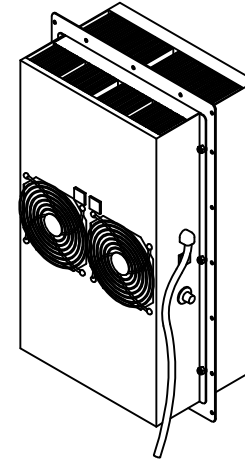
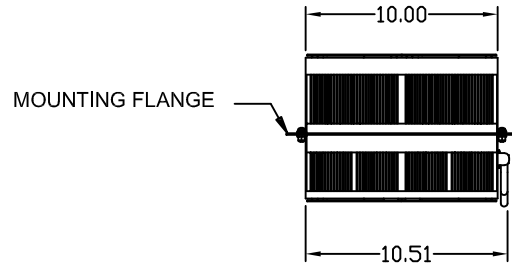
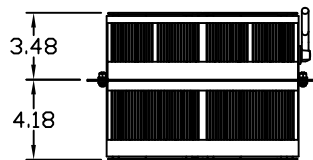

Title: AAC-145 AND AAC-146 NF SERIES ASSEMBLY		MATERIAL: STAINLESS STEEL BODY UNLESS NOTED ALUMINUM HEAT SINKS	
TOLERANCES UNLESS NOTED	EIC Solutions, Inc. 700 Veterans Way, Suite 200 Warminster, PA 18974 (215) 443-5190 FAX: (215) 443-9564 www.eicsolutions.com	FINISH: BRUSHED UNLESS NOTED	
		DRAWN: SFB	SCALE: 1:10
FRACTIONS ±1/32 2 PLACES ±0.03 3 PLACES ±0.015 ANGLES ± 1°		DATE: 08/09/16	DWG #: AA-2326
		SHEET #: 1 OF 1	