

OPTIONAL ITEMS SUCH AS LIFTING EYES, BOLT-DOWN LEGS, SHELVES, AND CASTERS ARE NOT SHOWN.

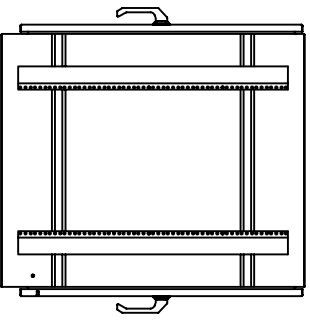

LEFT SIDE VIEW WITH INTERNAL RACK RAILS SHOWN

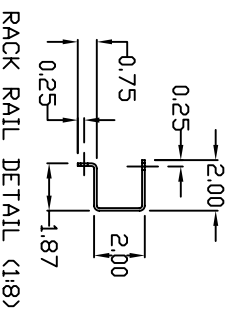
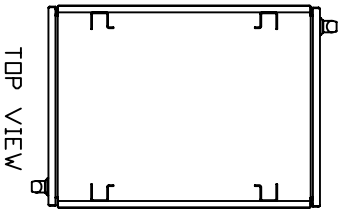
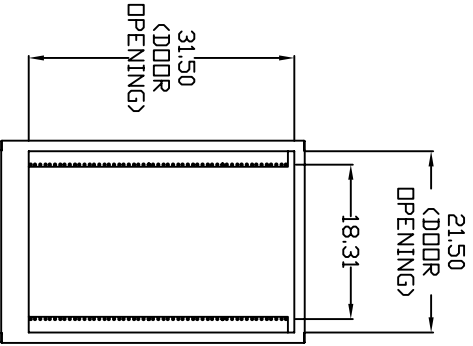

FRONT VIEW WITH DOOR REMOVED

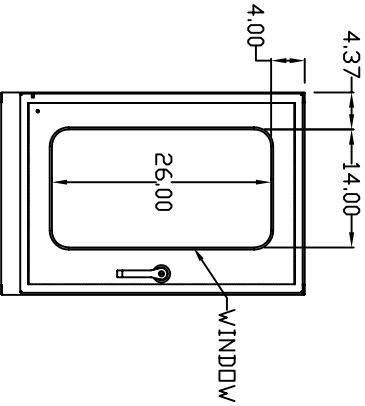

FRONT VIEW

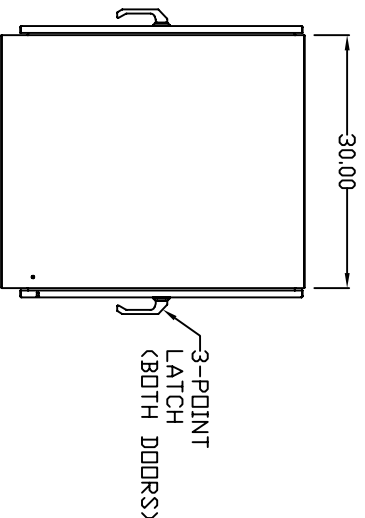

RIGHT SIDE VIEW

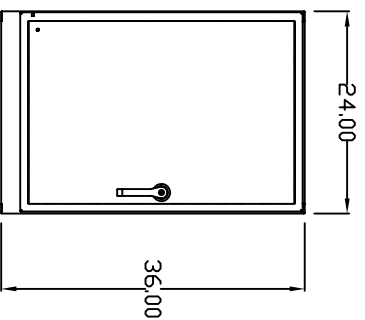

REAR VIEW



BOTTOM VIEW

THE INFORMATION CONTAINED HEREIN IS PROPRIETARY AND CONFIDENTIAL TO EIC SOLUTIONS, INC. ANY USE, TRANSFER OR DUPLICATION OF THIS INFORMATION IS STRICTLY FORBIDDEN WITHOUT THE EXPRESS WRITTEN CONSENT OF EIC SOLUTIONS, INC.

TOLERANCES UNLESS NOTED

FRACTIONS ±1/32
2 PLACES ±.03
3 PLACES ±.015
ANGLES ± 1'

EIC SOLUTIONS, INC.
1825 Stout Dr., Warminster, PA 18974
(215) 443-5190 FAX: (215) 443-9564
WWW.EICSOLUTIONSINC.COM

NAME:

362430-RM

DRAWN: SFB

SCALE: 1:24

REV

DATE: 11/01/11

DWG #:

SALES