

REQUIRES NON-STANDARD
LATCHING ARRANGEMENT
AS SHOWN

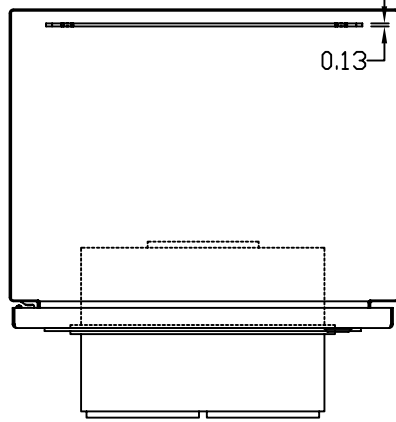

TOP VIEW

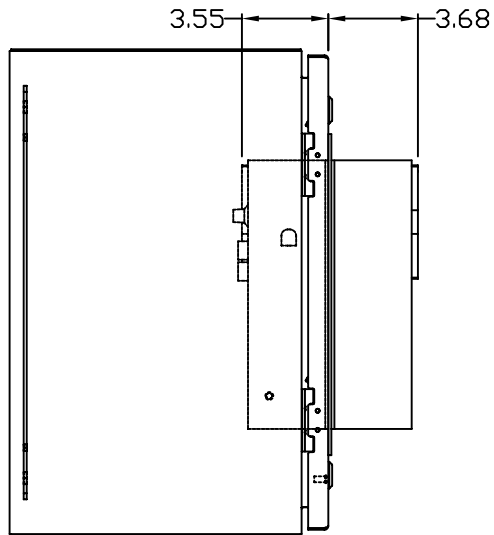

LEFT SIDE VIEW

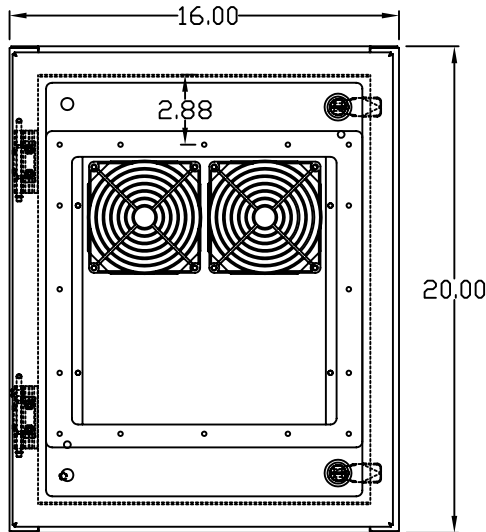

FRONT VIEW

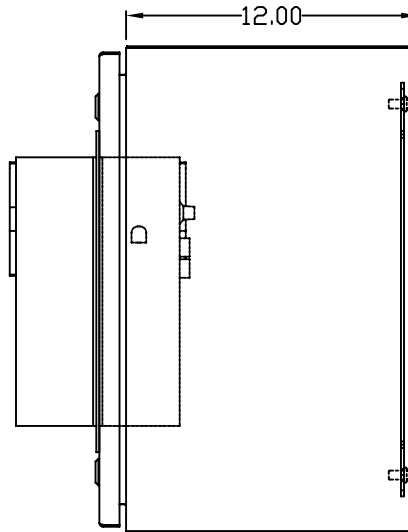

RIGHT SIDE VIEW

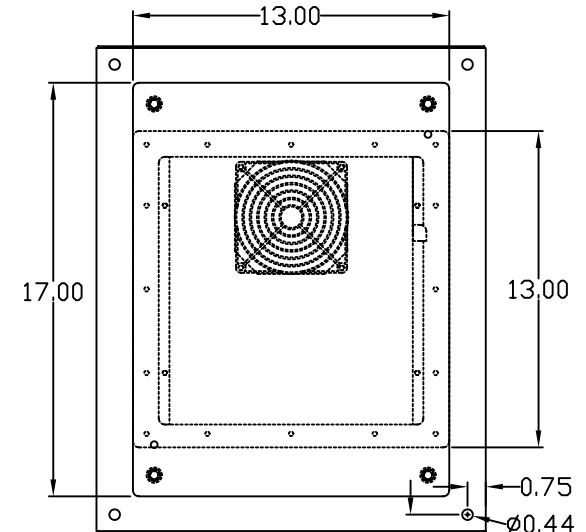

REAR VIEW

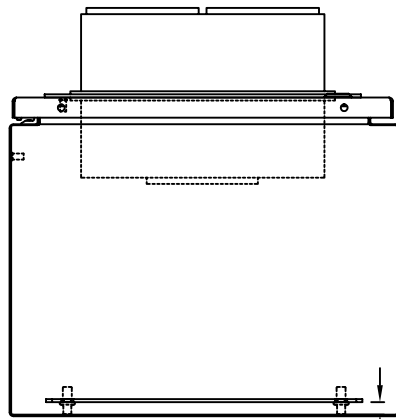

BOTTOM VIEW

THE INFORMATION CONTAINED HEREIN IS
PROPRIETARY AND CONFIDENTIAL TO
EIC SOLUTIONS, INC. ANY USE,
TRANSFER OR DUPLICATION OF THIS
INFORMATION IS STRICTLY FORBIDDEN
WITHOUT THE EXPRESS WRITTEN
CONSENT OF EIC SOLUTIONS, INC.

TOLERANCES
UNLESS NOTED
FRACTIONS 1/100
2 PLACES & .00
3 PLACES & .010
ANGLES ± 1°

EIC SOLUTIONS, INC.
1825 Stout Dr., Warminster, PA 18974
(215) 443-5190 FAX: (215) 443-9564
WWW.EICSOLUTIONSINC.COM

NAME: G201612-141-FRONT
DRAWN: SFB SCALE: 1/4"=1" REV
DATE: 07/08/10 DWG #