

TOP VIEW

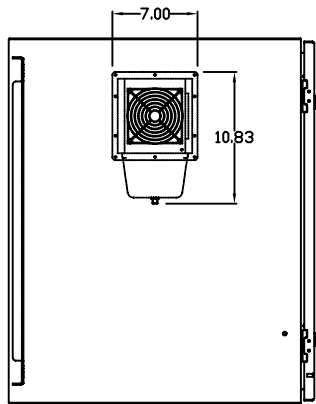

LEFT SIDE VIEW

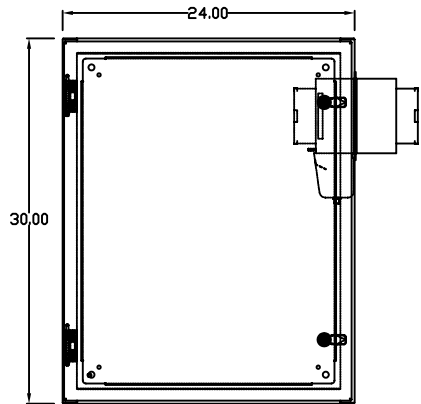

FRONT VIEW

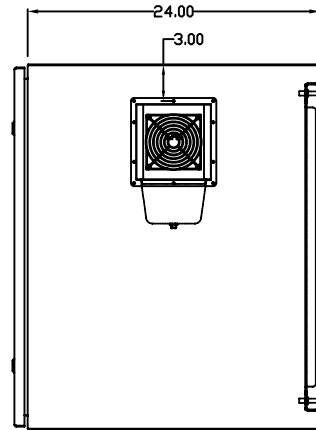

RIGHT SIDE VIEW

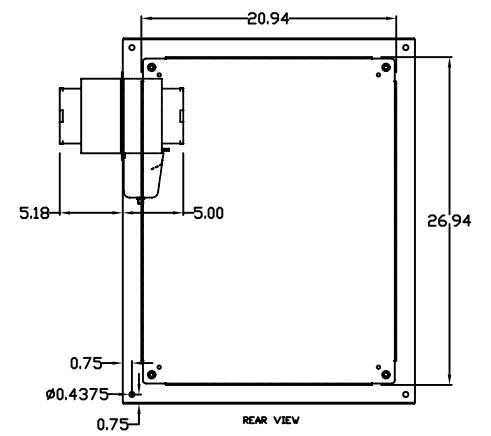

REAR VIEW

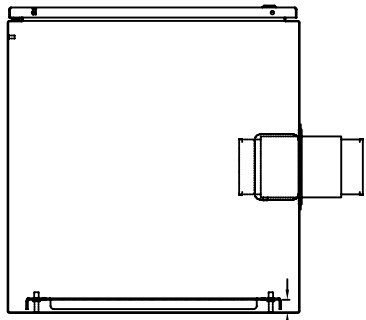

BOTTOM VIEW

THE INFORMATION CONTAINED HEREIN IS PROPRIETARY AND CONFIDENTIAL TO EIC SOLUTIONS, INC. ANY USE, TRANSFER OR DUPLICATION OF THIS INFORMATION IS STRICTLY FORBIDDEN WITHOUT THE EXPRESS WRITTEN CONSENT OF EIC SOLUTIONS, INC.

TOLERANCES UNLESS NOTED  
 FRACTIONS 1/100  
 2 PLACES 0.01  
 3 PLACES 0.015  
 ANGLES 1°

EIC SOLUTIONS, INC.  
 1825 Stout Dr., Warminster, PA 18974  
 (215) 443-5190 FAX: (215) 443-9564  
 WWW.EICSOLUTIONSINC.COM

NAME: G302424-140-RS  
 DRAWN: SFB SCALE: 1/8"=1" REV  
 DATE: 07/15/09 DWG #