

EIC SOLUTIONS, INC.



EIC SOLUTIONS

**THERMOELECTRIC AIR CONDITIONER INSTALLATION AND
OPERATION MANUAL**

FOR 800 BTU MODEL #'S

**AAC-141-T-E
AAC-141-4XT-E
AAC-141-T-E-HC
AAC-141-4XT-E-HC
AAC-141-XXXXX**

***COOLING SOLUTIONS FOR
MISSION-CRITICAL ELECTRONICS***

TABLE OF CONTENTS

- 1. GENERAL INFORMATION**
 - 1.1 PRINCIPLES OF OPERATION..... 3**

- 2. INSTALLATION**
 - 2.1 CHOOSING A LOCATION..... 4**
 - 2.2 ORIENTATION..... 4**
 - 2.3 PREPARING THE ENCLOSURE..... 6**
 - 2.4 INSTALLING THE AIR CONDITIONER..... 6**
 - INSTALL THE DRIP PAN..... 7**
 - APPLY POWER..... 7**

- 3. OPERATION**
 - 3.1 THERMOSTAT SET POINTS AND HEATING COOLING UNITS..... 9**
 - 3.2 MAINTENANCE..... 9**

- 4. APPENDIX..... 10**

EIC SOLUTIONS INC.
700 VETERANS WAY, SUITE 200
WARMINSTER, PA 18974
PHONE 1-215-443-5190 OR 1-800-497-4524
FAX 215-443-9564
EMAIL INFO@EICSOLUTIONS.COM

VISIT US ON THE WEB AT WWW.EICSOLUTIONS.COM.

1. GENERAL INFORMATION

1.1 PRINCIPLES OF OPERATION

In 1834 Jean Peltier discovered that by passing a current through two dissimilar conductors the junction of those materials will either absorb or release heat depending on the direction of the current flow. Thirteen years earlier Thomas Seebeck had discovered that current would flow when you placed a temperature gradient across the junction of two dissimilar metals. These two discoveries were the basis of thermoelectrics. With the advent of modern semiconductors thermoelectric devices became practical for real world applications and are now found in everything from consumer goods to spacecraft.

Your EIC Solutions Thermoelectric Air Conditioner operates on this principle so there is no compressor and no expensive, ozone depleting CFC's. EIC's air conditioners use Thermoelectric "modules" sandwiched between high performance aluminum heat sinks, high CFM axial fans, and a patented electronic design to "pump" the heat from the inside of your enclosure to the outside, without exposing your delicate electronics to any outside air or contaminants. See Figure 1.1.

EIC uses only the highest quality components in our air conditioners and you can expect years of trouble free cooling from these solid-state devices. Every unit we sell is backed by our one year parts and labor warranty.

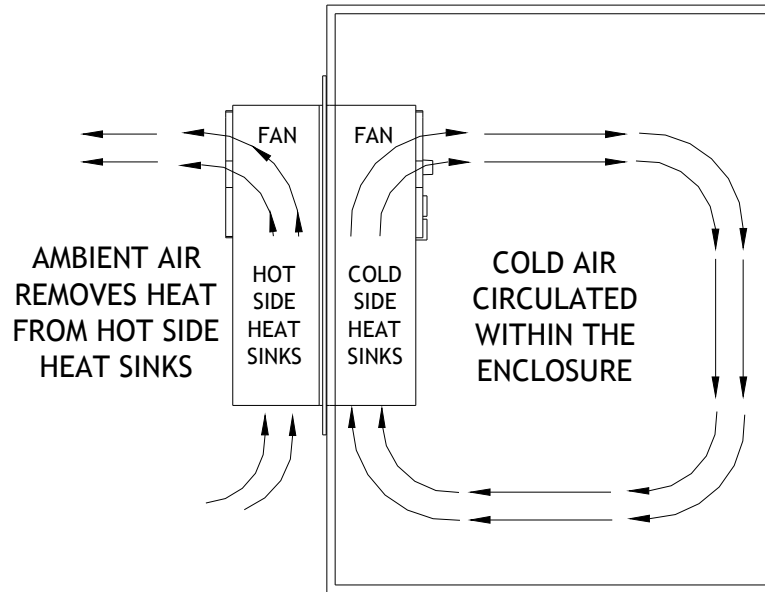

FIGURE 1.1

2. INSTALLATION

2.1 CHOOSING A LOCATION ON YOUR ENCLOSURE

When choosing a mounting location for your unit, be sure to keep air flows of both the interior and exterior heatsinks and fans in mind. Adequate clearance between the fans/heatsinks and nearby surfaces is required for unrestricted air flows which will ensure optimal performance and long, trouble free operation. The general rule is to allow a minimum of two inches between the fans or heatsinks and any surface. Refer to figure 1.1 for an air flow diagram.

Other considerations in deciding on a mounting location include; allowing access to thermostat (this will be inside the enclosure) if frequent adjustments are to be made; allowing access to the hot side heat sinks (this will be on the outside of the enclosure) for cleaning if the unit will be used in a harsh, dirty environment.

2.2 ORIENTATION

Your AC unit can be mounted either vertically on the front, rear or side of your enclosure or horizontally on the top of your enclosure. See Figure 2.1 and 2.2.

Vertically mounted 800 Btu units are always mounted with the exposed heatsink fins at the bottom and the fans at the top. (Fig. 2.1) Vertical installations often require the use of a Condensate Drip Pan (part # DP-V) depending on a number of factors including internal enclosure temperatures and ambient temperatures, humidity levels, quality of enclosure seals, and frequency of enclosure opening. **We strongly recommend the use of a drip pan to protect the electronics from dripping condensate.** (Fig. 2.1)

Mounting the unit with the fins pointing to either side or straight up will cause condensate to drip in an uncontrolled manner, possibly damaging electronic equipment within the enclosure. If one of these orientations is the only possible configuration, contact the Engineering Dept. at EIC for a custom solution.

Horizontally mounted 800 Btu units always require a drip pan (part # DP-141H) to prevent dripping condensate from damaging electronic equipment. (Fig. 2.2)

In either orientation, issues regarding access should be considered and minimum clearances must be maintained as outlined in Section 2.1 of this manual.

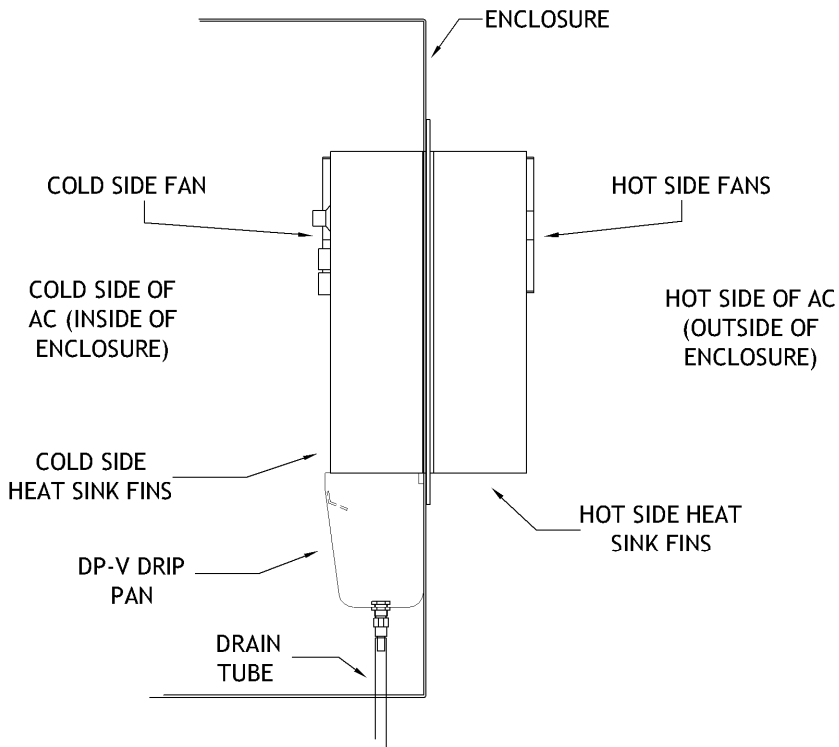

VERTICAL INSTALLATION OF 800 BTU UNIT WITH DP-V VERTICAL DRIP PAN AND DRAIN TUBE

FIGURE 2.1

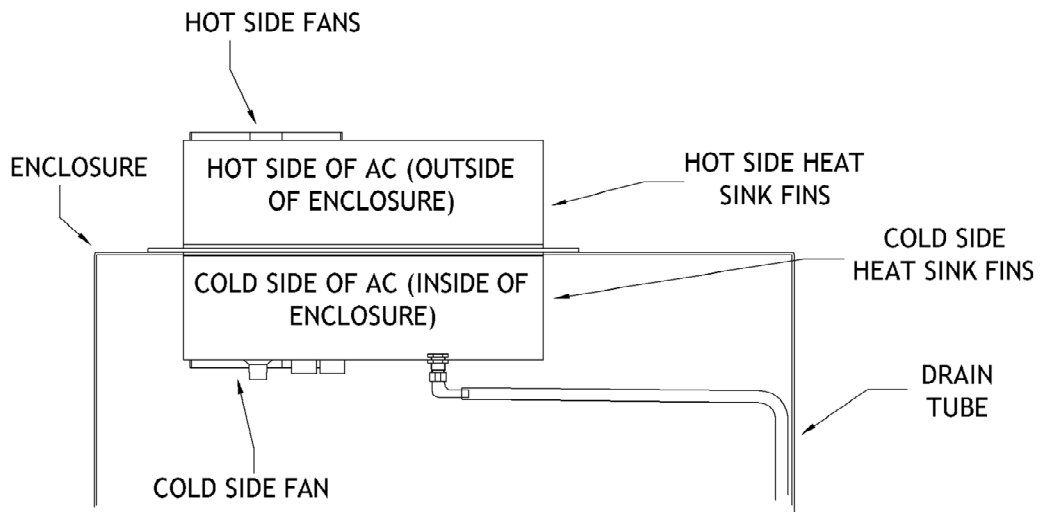

HORIZONTAL INSTALLATION OF 800 BTU UNIT WITH INTERNALLY MOUNTED DP-141H DRIP PAN AND DRAIN TUBE

FIGURE 2.2

2.3 PREPARING THE ENCLOSURE

To mount the 800 Btu unit you will need to cut an opening in your enclosure and drill mounting holes. Cut-out drawings (see Appendix A,B) showing the cut-out sizes and hole locations have been included in this manual. The instructions for installing the air conditioner are printed below.

TOOLS AND MATERIALS NEEDED:

- Pencil
- Scissors
- Tape Measure
- Jigsaw or suitable alternative
- Electric drill
- # 29 drill bit (.136") (Not used for extension frame option)
- # 8-32 tap and tap handle (Not used for extension frame option)
- .203" drill bit (Extension frame option only)
- # 8-32 x 3/8" stainless machine screws (supplied)
- Nylon washers to be used in NEMA 4X installations (supplied)
- One neoprene gasket (supplied)

CUT THE OPENING AND DRILL MOUNTING HOLES IN THE ENCLOSURE

1. Using the guidelines provided in the installation manual choose an appropriate location for the air conditioner on your enclosure.
2. Layout the cut-out and hole pattern for the AC on the enclosure. Refer to Appendix A for standard flange only. Standard flange air conditioners do not contain NF in the part number, and the mounting flange measures 13" x 13". Refer to Appendix B for narrow flange models only. Air conditioners that are narrow flange units contain NF in the part number, and the mounting flange measures 13" x 12".
3. Before cutting or drilling check that the location meets the clearance requirements as specified in the installation manual.
4. Using a pencil, center punch or other method, mark the exact center point of each mounting hole on the enclosure. You will use 8 holes for a NEMA 12 installation and all 16 holes for a NEMA 4X installation.
5. Using the jigsaw, cut the opening in the enclosure.
6. Using the appropriate drill bit, drill a hole at each of the marks you made earlier.
7. Using the 8-32 tap, tap each of the holes you have drilled. (Non-Extension Frame Only)

2.4 INSTALLING THE AIR CONDITIONER

INSTALL THE AIR CONDITIONER

1. Lay the air conditioner down with the thermostat facing up.
2. Take the supplied gasket and lay it down on the flange.
3. Take one of the supplied mounting screws and, from the underside of the flange, push it up through the top, right mounting hole, and through the hole in the gasket. The gasket hole is undersized and will hold the screw in place. Repeat this on the top left mounting hole.
4. Set the AC unit in the hole you've cut in the enclosure, and using a screwdriver, carefully secure the two screws you attached to the gasket to the tapped holes in the enclosure. Do not tighten these at this time.

5. Install the rest of the screws in the flange placing a nylon washer on each fastener and screw them into the tapped holes in the enclosure.
 - a. If you have purchased a vertical drip pan, you will need to install the three long screws in the three center holes in the bottom flange.
 - b. If this is an indoor installation with no chance of exposure to water or other liquids, you can use 8 screws per the NEMA 12 pattern in the Appendix.
 - c. If this is a NEMA 4X installation (outdoors or chance of exposure to liquids) use all 16 screws provided.
6. Remove the two started screws and place a nylon washer on each and reinstall.
7. Tighten all screws.

INSTALL THE DRIP PAN

1. Two hose fittings were provided with the drip pan, a right angle and a straight one. Choose one and install it on the drip pan. Be sure if you use the right angle fitting it is facing the desired direction prior to installing the drip pan.
2. There are three mounting holes in the drip pan, match these with the long mounting screws protruding into the enclosure at the bottom of the AC unit. Push the drip pan onto these screws.
3. Using the three 8-32 keps nuts provided, attach the drip pan to the air conditioner.
4. Attach the supplied PVC drain tube to the hose fitting on the drip pan. This tube should be routed to the bottom of the enclosure and fed through a 3/8" hole to the outside.
5. If you purchased a horizontal drip pan, it is installed at the factory and you will only need to install the hose fitting and PVC drain hose.

YOU MUST USE A HORIZONTAL DRIP PAN IF YOU INSTALL THE AIR CONDITIONER HORIZONTALLY (FIG 2.2) ON THE TOP OF YOUR ENCLOSURE. FAILURE TO DO SO MAY ALLOW CONDENSATE TO DRIP IN AN UNCONTROLLED MANNER CAUSING DAMAGE TO YOUR EQUIPMENT.

APPLY POWER

Once the air conditioner is mounted, check the serial label and confirm the voltage required and then apply appropriate power as outlined below.

120 VAC units - plug into standard 120 volt, grounded outlet. Amperage for a 120 VAC unit is 3.5 amps.

220 - 240 VAC units - this unit will not have a plug on the end. Connect the wires to an appropriate power source using standard safe wiring methods. Wire colors are as follows:

Black or Brown - line

White or Blue - line/neutral

Green or Green/Yellow - ground

A wiring diagram is shown in Fig. 2.4. Amperage for a 220 VAC unit is 2.5 amps.

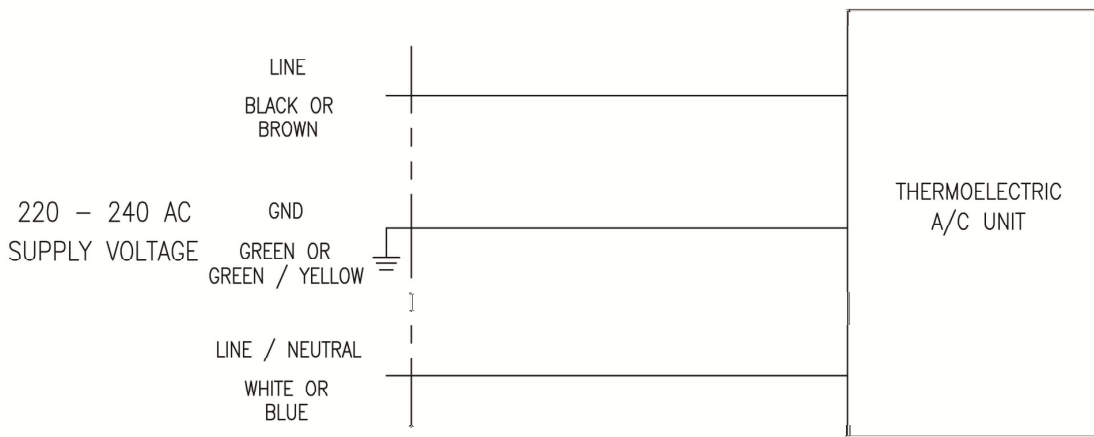

Figure 2.4

DC voltage units - this unit will not have a plug on the end. Connect the wires to an appropriate power source using standard safe wiring methods. Wire colors are as follows:

- Red - Positive
- Black - Negative
- Green - ground

A wiring diagram is shown in Fig. 2.5 below.

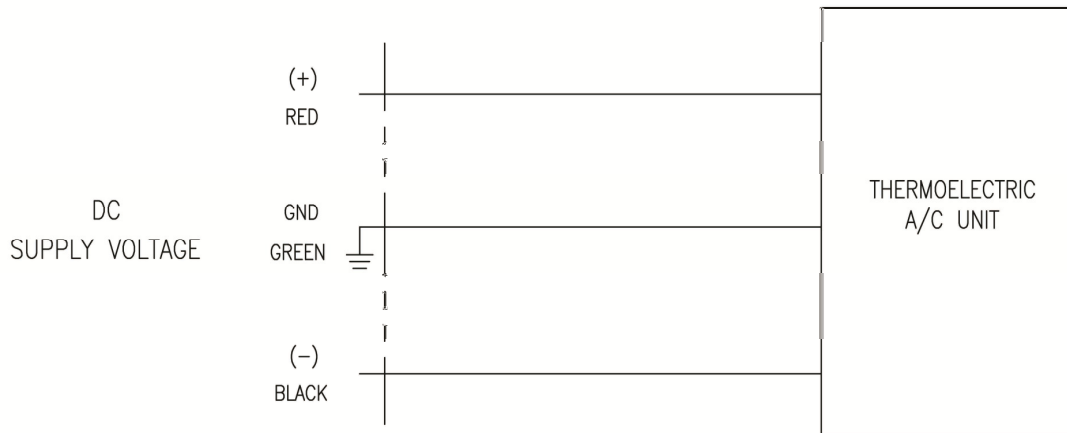

Figure 2.5

For other voltages you will receive a separate wiring diagram showing the correct method of applying power.

If you purchased a Digital Temperature Controller with your AC unit, a separate wiring diagram has been provided which will show the correct method of applying power to your particular air conditioner.

Upon applying power to the air conditioner the fan on the cold side (inside the enclosure) will come on. The hot side fans (outside the enclosure) may also run depending on where the thermostat is set. The cold side fan always runs to circulate air within your enclosure thereby eliminating any “hot spots”. The hot side fans will only run when the air conditioner is cooling - they are “pumping” the heat from the inside of your enclosure to the outside air.

3. OPERATION

3.1 THERMOSTAT SET POINTS AND HEATING/COOLING UNITS

SETTING THE THERMOSTAT

Your EIC air conditioner is equipped with an adjustable thermostat. The set point you choose should be based on the desired internal temperature of the enclosure. The air conditioner will run until the set point temperature is achieved within the enclosure and then the hot side fans and the thermoelectric cooling modules will shut down. The cold side fan will continue to run, circulating the air to maintain a uniform temperature within the enclosure.

HEATING AND COOLING UNITS

If you purchased an HC unit (heating and cooling), the heater operation is controlled by a fixed-point thermostat. This thermostat is set to turn the heaters on when the temperature within the enclosure falls to approximately 45° F and turn the heaters off when the temperature rises to approximately 55° F.

The cooling operation is controlled by the adjustable thermostat. To avoid having the heating and cooling on at the same time, do not set the cooling thermostat below 70° F.

3.2 MAINTENANCE

MAINTENANCE

EIC Thermoelectric Air Conditioners are virtually maintenance-free. The only time maintenance is required is when a unit is installed in an extremely dirty environment. In these cases, the hot side heat sinks (outside the enclosure) should be inspected regularly for a build-up of dust or dirt. If a build-up is present on the heat sink fins, it can be easily removed as follows:

1. Disconnect the power from the unit.
2. Dry dust/dirt can be removed using compressed air to blow out the heat sinks. Do not direct any high-pressure air at the fans.
3. NEMA 4X models of our air conditioners are designed to allow for water wash down of the hot side of the unit, which is outside of the enclosure **(never the cold side which is inside the enclosure)**. A pressure washer can be used to carefully clean the hot side heat sink fins. Never direct high-pressure water at the fans or the joint formed by the mounting flange, gasket and enclosure. Never allow the cold side of your unit to get wet. Always check your serial label before proceeding with a water wash down.

Keeping the hot side heat sink fins free from any insulating build-up of dirt or dust will ensure long, trouble-free operation of your air conditioner.

ONLY NEMA 4X UNITS, WITH MODEL NUMBERS BEGINNING WITH “AAC-141-4XT”, ARE DESIGNED FOR THE HOT SIDE OF THE AIR CONDITIONER (OUTSIDE THE ENCLOSURE) TO TOLERATE EXPOSURE TO WATER.

NEMA 12 UNITS, WITH MODEL #'S BEGINNING WITH “AAC-141-T”, ARE NOT DESIGNED TO BE EXPOSED TO WATER AND SHOULD NEVER BE WASHED DOWN.

NEVER EXPOSE THE COLD SIDE OF ANY AIR CONDITIONER (INSIDE THE ENCLOSURE) TO WATER.

If you have any questions about any aspect of your EIC air conditioner, don't hesitate to call us at the numbers listed below.

APPENDIX A AND B

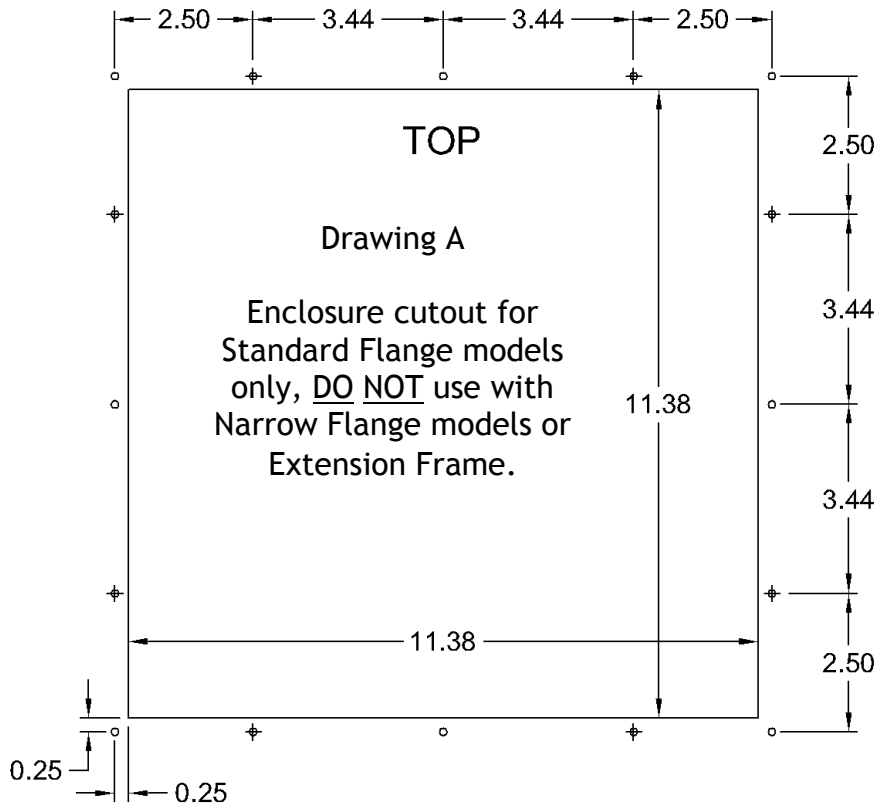

NEMA 12 installations:
Use holes marked with + (10x)

NEMA 4 installations:
Use all holes (20x)

Holes to be 8-32 TAP

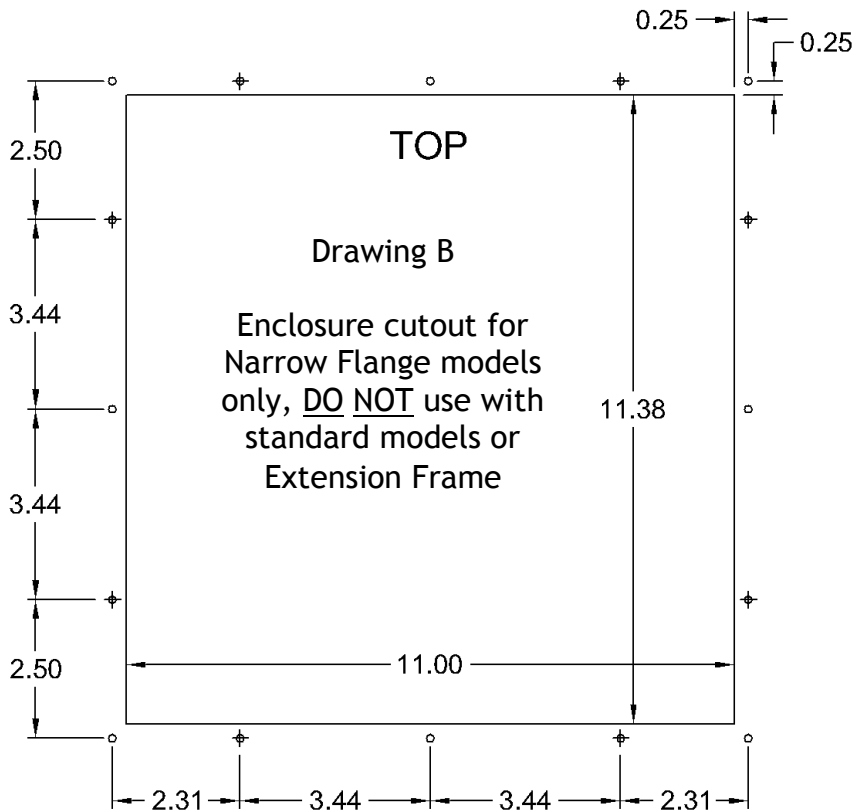

APPENDIX C

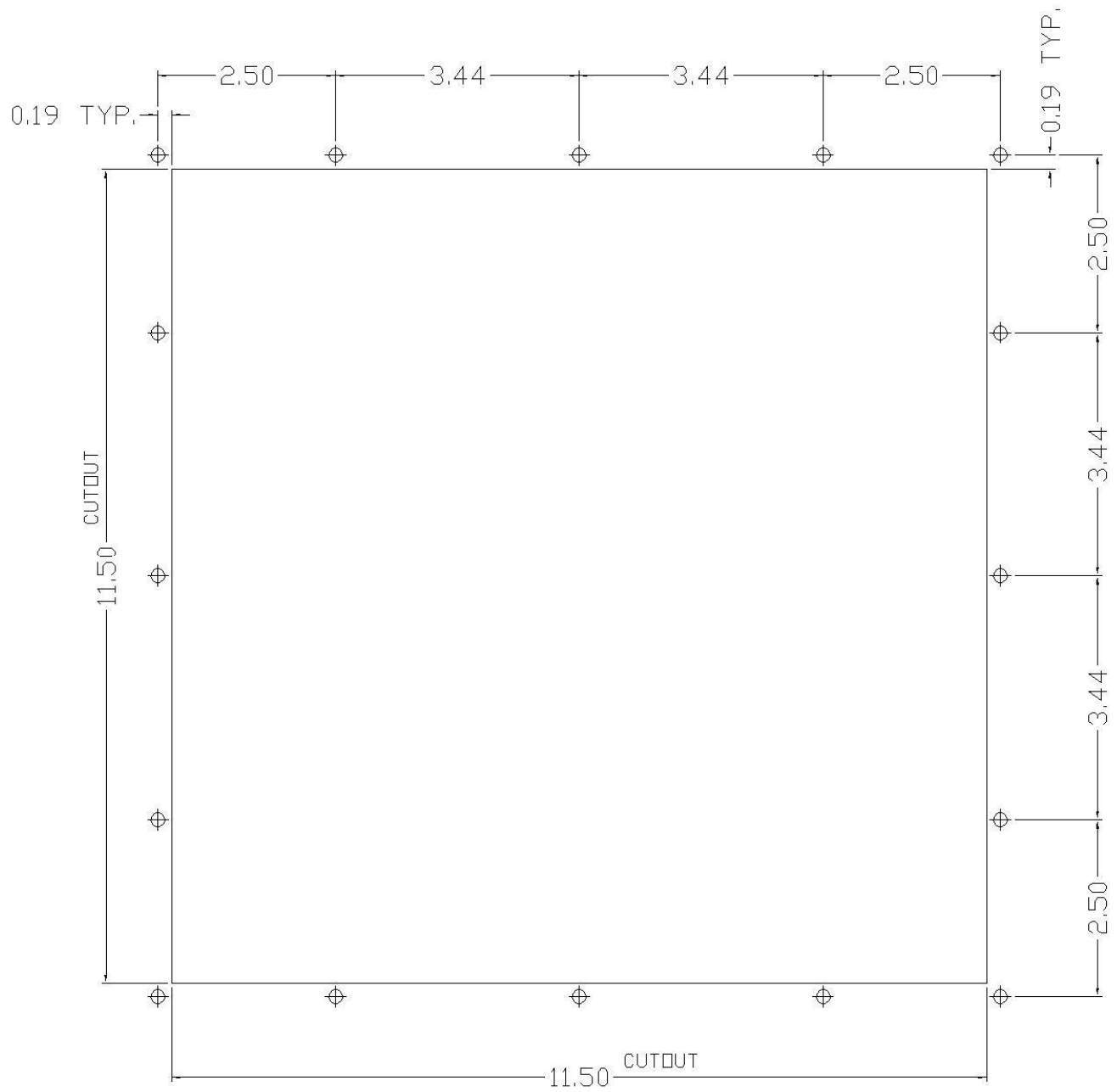

Enclosure cutout for 800 BTU air conditioner
EXTENSION FRAME ONLY

Holes to be .203"